

4

3

2

1

F

F

E

E

D

D

C

C

B

B

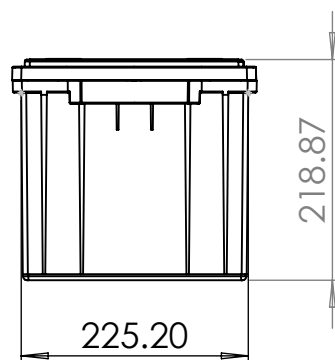
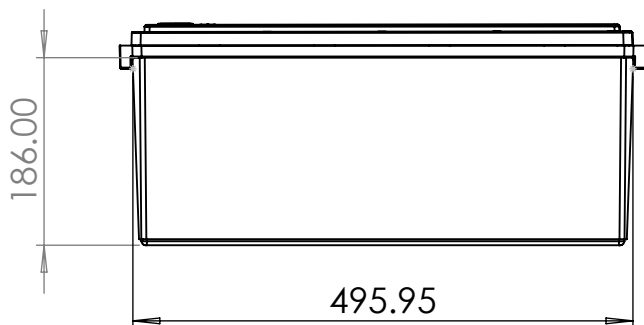
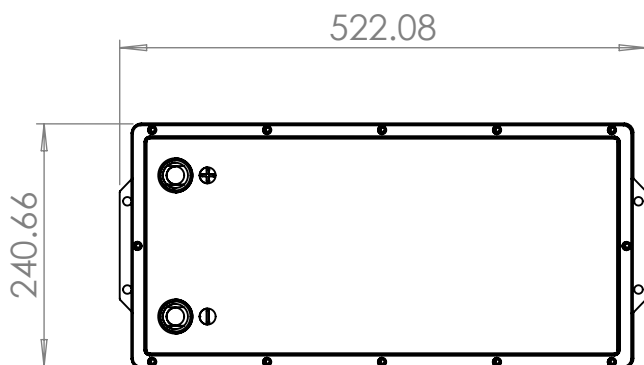
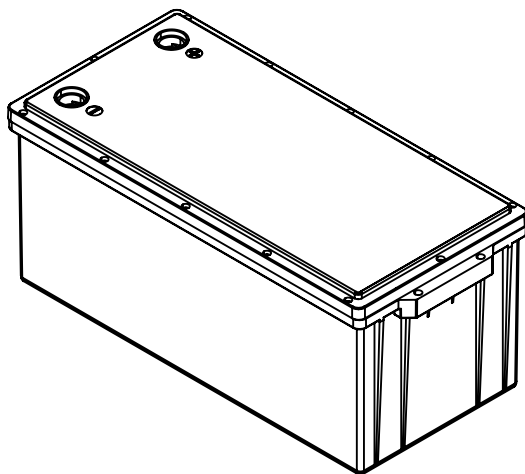

A

A

PRODUCT	24V 100XTREME
MPN	24100X1
DRAWING DATE	28/07/2023
REVISION	1.0



ROAMER

DO NOT SCALE DRAWING	A4	1:7.5	MMGS	SHEET 1 OF 1
----------------------	----	-------	------	--------------

4

3

2

1