

# Roamer 24-100 XTREME

25.6V 100AH 250A LiFePO4

The Roamer 24-100XTREME is a 100Ah 24V battery using specialist cells which can operate at much lower temperatures than standard LFP. This means that XTREME batteries don't suffer irreversible damage when used outside of typical room temperatures. Ideal for installation in systems where there is no temperature control, such as outdoor applications.

For more information, visit [www.roamer.com/products/24-100xtreme](http://www.roamer.com/products/24-100xtreme)

## General Description

All Roamer batteries utilise Lithium Iron Phosphate (LFP or LiFePO4) cell chemistry combined with an intelligent, wireless connected Battery Management System (BMS). Roamer only use Grade A cells direct from the manufacturer, matched at the factory to ensure coherent operation and maximise service life and safety. The batteries are constructed around a custom fabricated steel chassis which supports and protects the cells from mechanical impacts and vibration and facilitates high levels of serviceability, ensuring that our batteries can be upgraded or serviced to maximise the service of the product.

Fire retardant materials including fibreglass resin panels and high-density carbon-impregnated EVA foam are used to provide high quality electrical and thermal insulation, and mechanical protection. All batteries are fitted with female M8x1.25 terminals with large contact surface area. All batteries have multi-layered safety features as standard including over and under voltage, over and under temperature for both charge and discharge, short circuit detection, cell balance monitoring and more. High specification components are used to provide passive protection from accidental extremely DC overvoltage, reverse polarity, and momentary overcurrent.

## PRODUCT FEATURES

- 100Ah capacity at 25.6V.
- Intelligent cell balancing up to 0.1A.
- Grade A Cylindrical LT LFP cells.
- Up to 250A continuous discharge (6.4kW).
- Supports up to 2 batteries in series and 4 batteries in parallel for increased capacity, current delivery, voltage, or supply redundancy.
- Discharge between -40 °C and 60 °C, charge between -30 °C and 60 °C.



## Battery Dimensions

Unless otherwise indicated all linear dimensions are provided in mm and all angular dimensions are in degrees. Dimensions subject to manufacturing variation. Products may vary from those illustrated. This drawing is subject to change without notice.

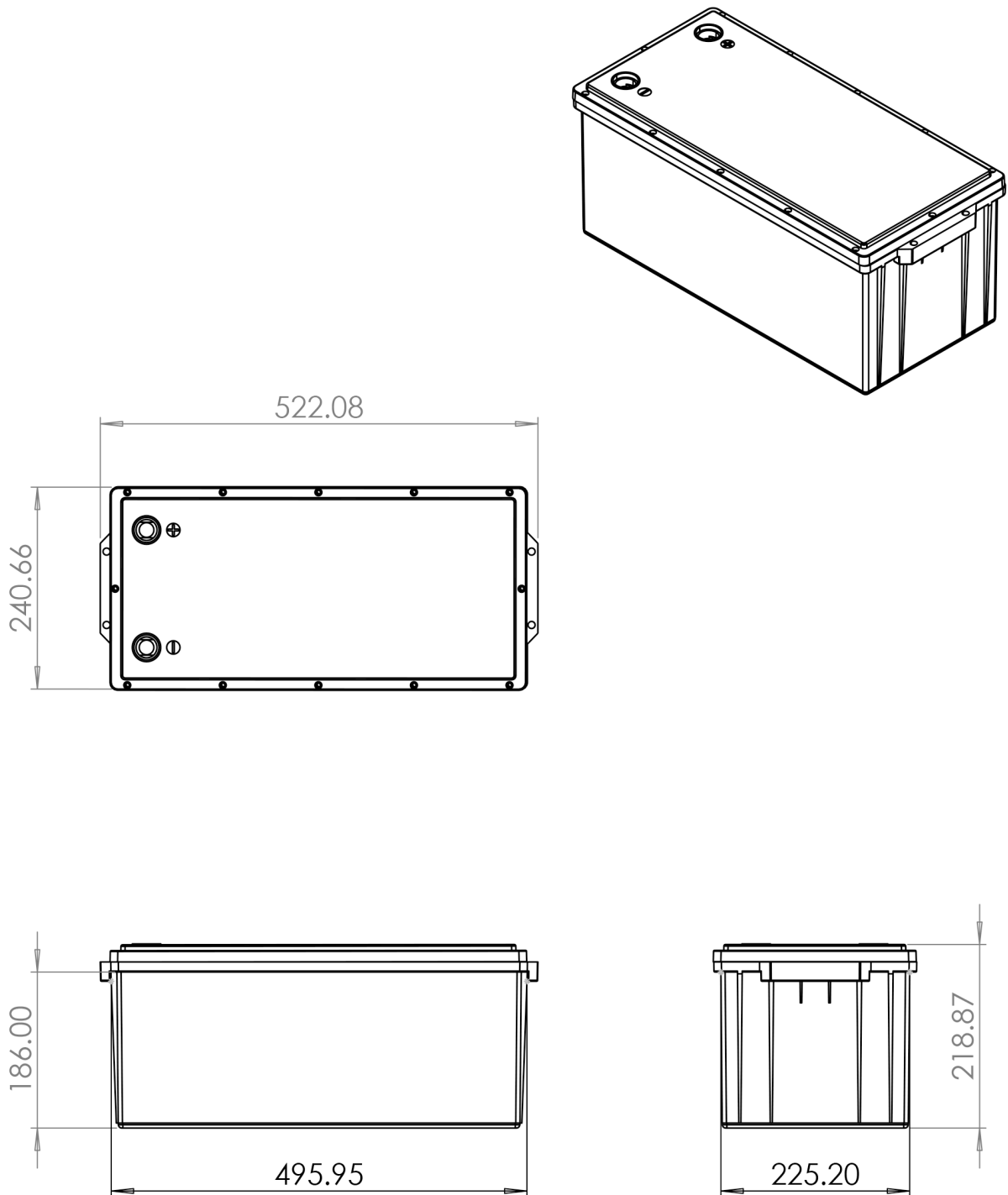

## Battery Specification

|                          | Identifier  | Min | Typical     | Max | Unit |
|--------------------------|-------------|-----|-------------|-----|------|
| Nominal Voltage          | $V_N$       | -   | 25.6        | -   | V    |
| Nominal Capacity         | $C_N$       | -   | 100         | 110 | Ah   |
| Energy Capacity          | $E_N$       | -   | 2560        | -   | Wh   |
| Cell Chemistry           | -           | -   | LT LFP      | -   | -    |
| Cell Type                | -           | -   | Cylindrical | -   | -    |
| Cell Capacity            | $C_C$       | 3.2 | 3.2         | -   | Ah   |
| Cell Configuration       | -           | -   | 8S 32P      | -   | -    |
| Pack Internal Resistance | $R_I$       | -   | -           | 20  | mΩ   |
| Parallel Limit           | $N_P^{MAX}$ | -   | -           | 4   | -    |
| Series Limit             | $N_S^{MAX}$ | -   | -           | 2   | -    |
| Cycle Life at 50% DoD    | -           | -   | 4000        | -   | -    |
| Cycle Life at 80% DoD    | -           | -   | 2000        | -   | -    |
| Cycle Life at 100% DoD   | -           | -   | 1500        | -   | -    |

## Physical Specification

|                        | Identifier | Min | Typical       | Max | Unit |
|------------------------|------------|-----|---------------|-----|------|
| Length                 | $L_L$      | -   | 521           | -   | mm   |
| Width                  | $L_W$      | -   | 242           | -   | mm   |
| Depth                  | $L_D$      | -   | 219           | -   | mm   |
| Mass                   | M          | -   | 23            | -   | kg   |
| Case Type              | -          | -   | ABS Permanent | -   | -    |
| Terminal Type          | -          | -   | M8 Female     | -   | -    |
| Terminal Torque Rating | $T_{MAX}$  | 9   | 10            | 11  | Nm   |
| IP Rating              | -          | -   | IP65          | -   | -    |

## Charging Parameters

|                         | Identifier       | Min  | Recommended | Max  | Unit |
|-------------------------|------------------|------|-------------|------|------|
| Battery Safe Voltage    | $V_{BS}$         | 20   | -           | 29.2 | V    |
| Battery Working Voltage | $V_{BW}$         | 21.6 | -           | 28.4 | V    |
| Nominal Cell Voltage    | $V_{CN}$         | 2.8  | -           | 3.7  | V    |
| Absorption Voltage      | $V_{CA}$         | -    | 28.4        | 29.2 | V    |
| Float Voltage           | $V_{CF}$         | -    | 27          | -    | V    |
| Maintenance Voltage     | $V_{CS}$         | -    | 26.4        | -    | V    |
| Charge Current Limit    | $I_C$            | 5    | -           | 250  | A    |
| Recommended Charge Rate | $R_C$            | -    | -           | 1    | ·C   |
| Charge Temperature      | $T_C$            | -30  | -           | 60   | °C   |
| Charge Current >25°C    | $I_{CMAX}^{25}$  | -    | -           | 100  | A    |
| Charge Current @ 10°C   | $I_{CMAX}^{10}$  | -    | -           | 100  | A    |
| Charge Current @ 5°C    | $I_{CMAX}^5$     | -    | -           | 100  | A    |
| Charge Current < 0°C    | $I_{CMAX}^0$     | -    | -           | 50   | A    |
| Charge Current < -20°C  | $I_{CMAX}^{-20}$ | -    | -           | 20   | A    |

## Discharging Parameters

|                              | Identifier | Min | Recommended | Max | Unit |
|------------------------------|------------|-----|-------------|-----|------|
| Peak Discharge Current       | $I_{CP}$   | 0   | -           | 250 | A    |
| Continuous Discharge Current | $I_{CC}$   | 0   | -           | 250 | A    |
| Recommended Discharge Rate   | $R_D$      | -   | -           | 2.5 | ·C   |
| Discharge Temperature        | $T_D$      | -40 | -           | 60  | °C   |

## Storage Parameters

|                                 | Identifier | Min | Recommended | Max  | Unit |
|---------------------------------|------------|-----|-------------|------|------|
| Recommended Storage Temperature | $T_S$      | 10  | -           | 35   | °C   |
| Recommended Storage SoC         | $S_S$      | 30  | 50          | 80   | %    |
| Recommended Storage Voltage     | $V_S$      | 26  | 26.4        | 26.5 | V    |

## BMS Parameters

|  | Identifier | Min | Typical | Max | Unit         |
|--|------------|-----|---------|-----|--------------|
| Cell Overcharge Detection Voltage            | $V_{COD}$  | -   | 3.65    | -   | V            |
| Cell Overcharge Release Voltage              | $V_{COR}$  | -   | 3.4     | -   | V            |
| Pack Overcharge Detection Current            | $I_{BOD}$  | -   | 400     | -   | A            |
| Pack Overcharge Release Current              | $I_{BOR}$  | -   | 0       | -   | A            |
| Overcharge Detection Time                    | $t_{OD}$   | -   | 1       | -   | s            |
| Cell Undercharge Detection Voltage           | $V_{CUD}$  | -   | 2.5     | -   | V            |
| Cell Undercharge Release Voltage             | $V_{CUR}$  | -   | 2.7     | -   | V            |
| Undercharge Detection Time                   | $t_{UD}$   | -   | 1       | -   | s            |
| Cell Balance Transfer Current                | $I_{CB}$   | -   | 0.1     | -   | A            |
| Cell Balance Trigger Delta Threshold Voltage | $V_{CBD}$  | -   | 0.1     | -   | V            |
| Short Circuit Detection Current              | $I_{SCD}$  | -   | 2000    | -   | A            |
| Short Circuit Protection Release Current     | $I_{SCR}$  | -   | 0       | -   | A            |
| Short Circuit Detection Time                 | $t_{SC}$   | -   | 400     | 600 | $\mu$ s      |
| Charge Temperature Protection                | $T_{CPD}$  | -30 | -       | -25 | $^{\circ}$ C |
| Charge Temperature Protection Release        | $T_{CPR}$  | 60  | -       | 55  | $^{\circ}$ C |
| Discharge Temperature Protection             | $T_{DP}$   | -40 | -       | -35 | $^{\circ}$ C |
| Discharge Temperature Protection Release     | $T_{DPR}$  | 60  | -       | 55  | $^{\circ}$ C |
| BMS Working Current Consumption              | $I_{WRK}$  | -   | 20      | -   | mA           |
| BMS Standby Current Consumption              | $I_{STBY}$ | -   | 800     | -   | $\mu$ A      |

## Battery Characteristics

The following graphs demonstrate the operational characteristics of LiFePo4 cells under a variety of conditions. Many factors play a role in the exact capacity, performance, lifetime and safety of a lithium battery so every installation varies depending on the exact setup and use case. These serve only as a guide and do not reflect the exact characteristics of any individual battery.

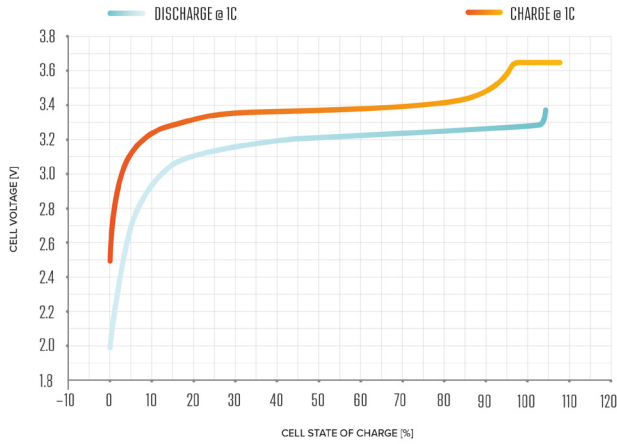

TYPICAL CHARGE & DISCHARGE VOLTAGE VS CHARGE STATE (SoC) CURVE OF A LiFePO<sub>4</sub> CELL (25 °C)

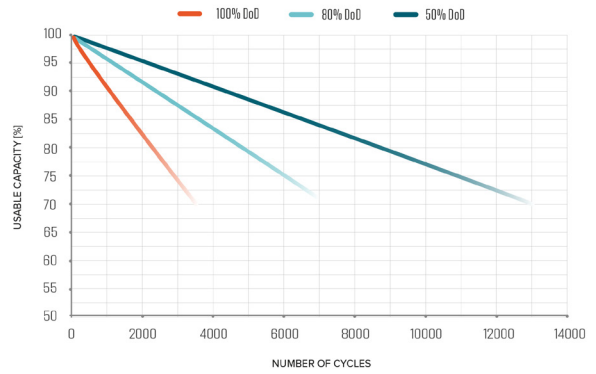

TYPICAL USABLE CAPACITY VS CYCLE LIFE FOR DIFFERENT DEPTHS OF DISCHARGE (0.5C, 25 °C)

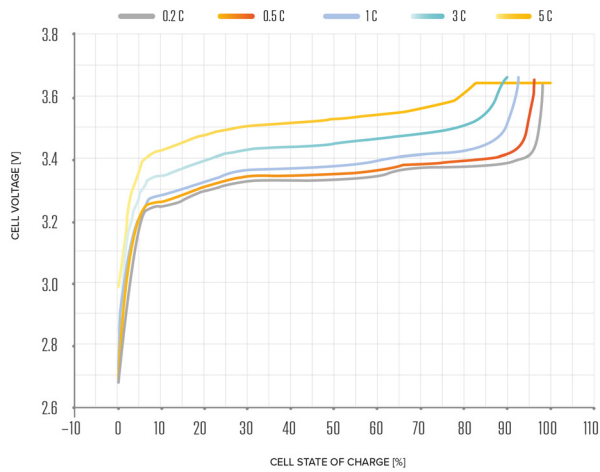

CELL VOLTAGE VS STATE OF CHARGE AT DIFFERENT CHARGE RATES (25 °C)

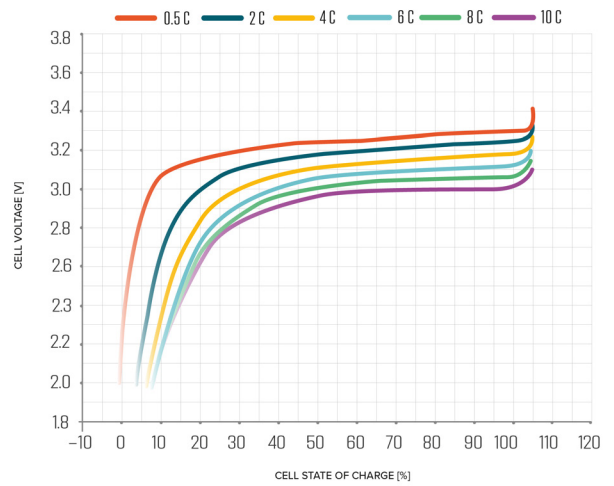

CELL VOLTAGE VS STATE OF CHARGE AT DIFFERENT DISCHARGE RATES (25 °C)

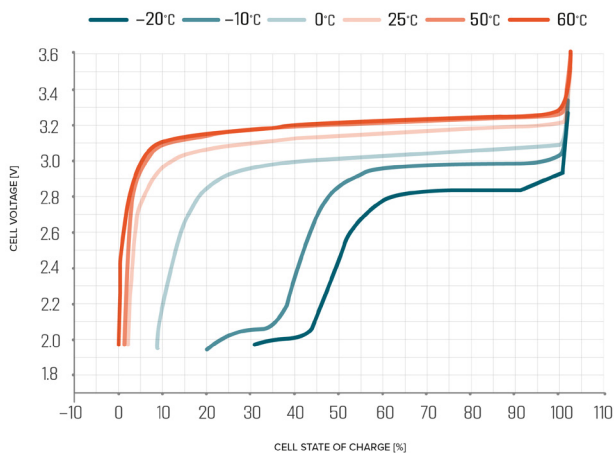

CELL VOLTAGE VS STATE OF CHARGE AT DIFFERENT TEMPERATURES

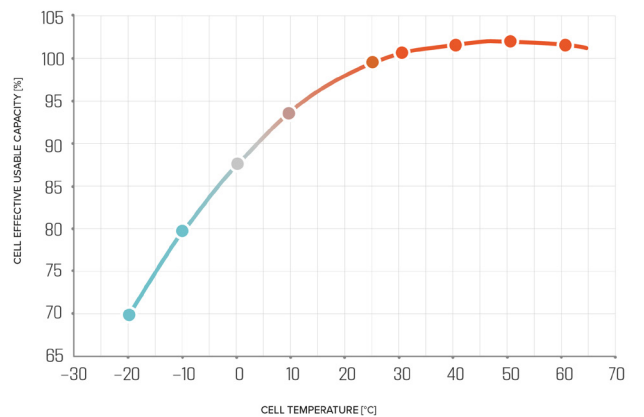

TYPICAL EFFECTIVE USABLE CAPACITY VS CELL TEMPERATURE

## Document Information

| Document Version | Release Date | Status  | Change Notice  |
|------------------|--------------|---------|----------------|
| 1.0              | 11/12/2022   | Release | Initial issue  |
| 2.0              | 16/08/2023   | Release | Major revision |
|                  |              |         |                |

All efforts have been made to ensure the data in this datasheet are correct and up to date. Roamer Batteries constantly monitor product documentation for inaccuracy and routinely update documentation to reflect the most accurate information available. This version of the document supersedes and replaces all information supplied prior to the publication hereof.

This page is left unintentionally blank.