

Roamer 105 SMART 4

12.8V 105AH 150A LIFEPO4

The Roamer 105SMART4 is a high power replacement for a standard Group 31 size lead acid leisure battery. It can deliver a significant improvement in power, weight, and storage capacity compared to equivalent FLA, gel or AGM leisure batteries.

For more information, visit www.roamer.com/products/105smart

General Description

All Roamer batteries utilise Lithium Iron Phosphate (LFP or LiFePO4) cell chemistry combined with an intelligent, Bluetooth connected Battery Management System (BMS). Roamer only use Grade A cells direct from the manufacturer, matched at the factory to ensure coherent operation and maximise service life and safety. The batteries are constructed around a custom fabricated steel chassis which supports and protects the cells from mechanical impacts and vibration and facilitates high levels of serviceability, ensuring that our batteries can be upgraded or serviced to maximise the service of the product.

Fire retardant materials including fibreglass resin panels and high-density carbon-impregnated EVA foam are used to provide high quality electrical and thermal insulation, and mechanical protection. All batteries are fitted with female M10x1.25 terminals with large contact surface area. All batteries have multi-layered safety features as standard including over and under voltage, over and under temperature for both charge and discharge, short circuit detection, cell balance monitoring and more. High specification components are used to provide passive protection from accidental extreme DC overvoltage, reverse polarity, and momentary overcurrent.

PRODUCT FEATURES

- 105Ah capacity at 12.8V
- Intelligent cell balancing up to 2A
- Grade A Prismatic LFP cells
- Up to 150A continuous discharge (2.5kW)
- Supports up to 4 batteries in series and 16 batteries in parallel for increased capacity, current delivery, voltage, or supply redundancy
- Discharge between -20 °C and 60 °C, charge between 0 °C and 60 °C



Battery Dimensions

Dimensions subject to manufacturing variation. Products may vary from those illustrated. This drawing is subject to change without notice.

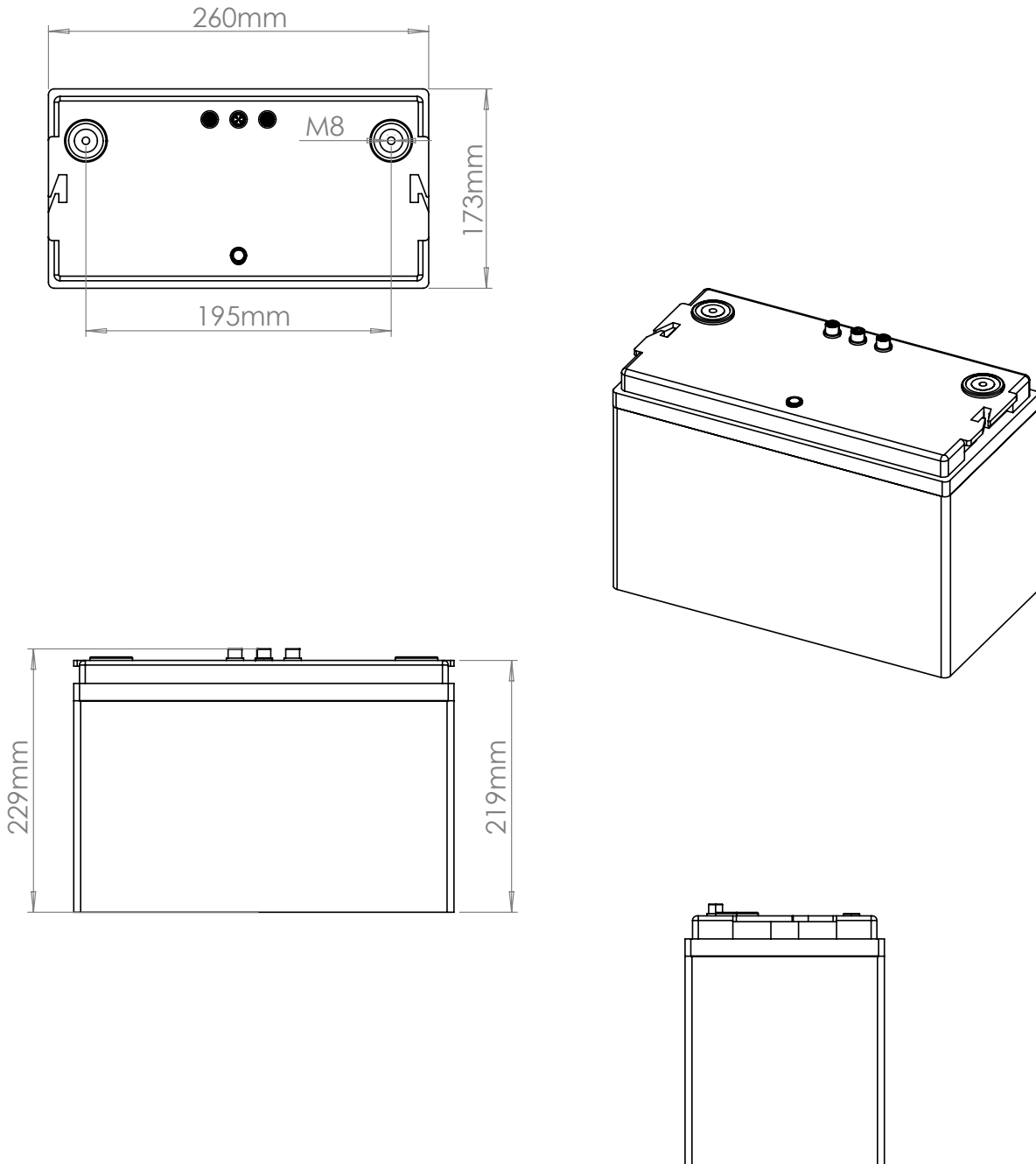

Battery Specification

	Identifier	Min	Typical	Max	Unit
Nominal Voltage	V_N	-	12.8	-	V
Nominal Capacity	C_N	-	105	116	Ah
Energy Capacity	E_N	-	2048	-	Wh
Cell Chemistry	-	-	LiFePO4	-	-
Cell Type	-	-	Prismatic	-	-
Cell Capacity	C_C	-	105	-	Ah
Cell Configuration	-	-	4S 1P	-	-
Pack Internal Resistance	R_I	-	-	20	mΩ
Parallel Limit	N_P^{MAX}	-	-	16	-
Series Limit	N_S^{MAX}	-	-	4	-
Cycle Life at 50% DoD	-	-	6500	-	-
Cycle Life at 80% DoD	-	-	3500	-	-
Cycle Life at 100% DoD	-	-	2000	-	-

Physical Specification

	Identifier	Min	Typical	Max	Unit
Length	L_L	-	260	-	mm
Width	L_W	-	173	-	mm
Depth	L_D	-	229	-	mm
Mass	M	-	11	-	kg
Case Type	-	-	ABS Serviceable	-	-
Terminal Type	-	-	M10 Female	-	-
Terminal Torque Rating	T_{MAX}	15	16	17	Nm
IP Rating	-	-	IP54	-	-

Charging Parameters

	Identifier	Min	Recommended	Max	Unit
Battery Safe Voltage	V_{BS}	10	-	14.6	V
Battery Working Voltage	V_{BW}	10.8	-	14.2	V
Nominal Cell Voltage	V_{CN}	2.8	-	3.7	V
Absorption Voltage	V_{CA}	-	14.4	14.6	V
Float Voltage	V_{CF}	-	13.5	-	V
Maintenance Voltage	V_{CS}	-	13.2	-	V
BMS Charge Current Limit	I_C	5	-	105	A
Recommended Max Charge Rate	R_C	-	-	50	A
Charge Temperature	T_C	0	-	60	°C
Charge Current >25°C	I_{CMAX}^{25}	-	-	50	A
Charge Current @ 10°C	I_{CMAX}^{10}	-	-	20	A
Charge Current @ 5°C	I_{CMAX}^5	-	-	10	A
Charge Current < 0°C	I_{CMAX}^0	-	-	0	A
Charge Current < -20°C	I_{CMAX}^{-20}	-	-	0	A

Discharging Parameters

	Identifier	Min	Recommended	Max	Unit
BMS Peak Discharge Current (30s)	I_{CP}	0	-	350	A
BMS Max Continuous Discharge Current	I_{CC}	0	-	150	A
Recommended Max Discharge Rate	R_D	-	-	105	A
Discharge Temperature	T_D	-20	-	60	°C

Storage Parameters

	Identifier	Min	Recommended	Max	Unit
Recommended Storage Temperature	T_S	10	-	35	°C
Recommended Storage SoC	S_S	30	50	80	%
Recommended Storage Voltage	V_S	13	13.2	13.25	V

BMS Parameters

	Identifier	Min	Typical	Max	Unit
Cell Overcharge Detection Voltage	V_{COD}	-	3.65	-	V
Cell Overcharge Release Voltage	V_{COR}	-	3.4	-	V
Pack Overcharge Detection Current	I_{BOD}	-	100	-	A
Pack Overcharge Release Current	I_{BOR}	-	0	-	A
Overcharge Detection Time	t_{OD}	-	1	-	s
Cell Undercharge Detection Voltage	V_{CUD}	-	2.5	-	V
Cell Undercharge Release Voltage	V_{CUR}	-	2.7	-	V
Undercharge Detection Time	t_{UD}	-	1	-	s
Cell Balance Transfer Current	I_{CB}	-	2	-	A
Cell Balance Trigger Delta Threshold Voltage	V_{CBD}	-	0.01	-	V
Short Circuit Detection Current	I_{SCD}	-	2200	-	A
Short Circuit Protection Release Current	I_{SCR}	-	5	-	A
Short Circuit Detection Time	t_{SC}	-	150	200	μ s
Charge Temperature Protection	T_{CPD}	0	-	60	$^{\circ}$ C
Charge Temperature Protection Release	T_{CPR}	5	-	55	$^{\circ}$ C
Discharge Temperature Protection	T_{DP}	-20	-	60	$^{\circ}$ C
Discharge Temperature Protection Release	T_{DPR}	-15	-	55	$^{\circ}$ C
BMS Working Current Consumption	I_{WRK}	-	30	-	mA
BMS Standby Current Consumption	I_{STBY}	-	800	-	μ A

Battery Characteristics

The following graphs demonstrate the operational characteristics of LiFePO₄ cells under a variety of conditions. Many factors play a role in the exact capacity, performance, lifetime and safety of a lithium battery so every installation varies depending on the exact setup and use case. These serve only as a guide and do not reflect the exact characteristics of any individual battery.

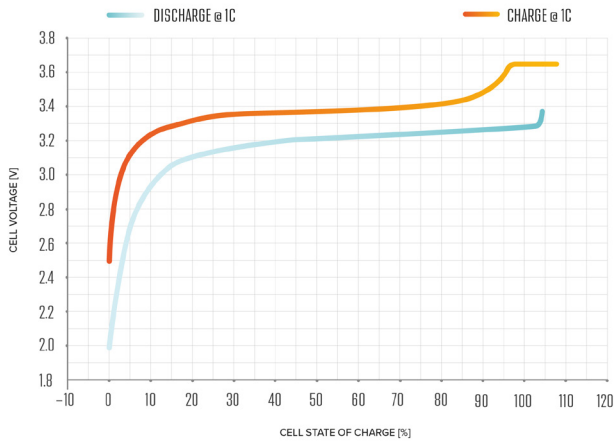

TYPICAL CHARGE & DISCHARGE VOLTAGE VS CHARGE STATE (SoC) CURVE OF A LiFePO₄ CELL (25 °C)

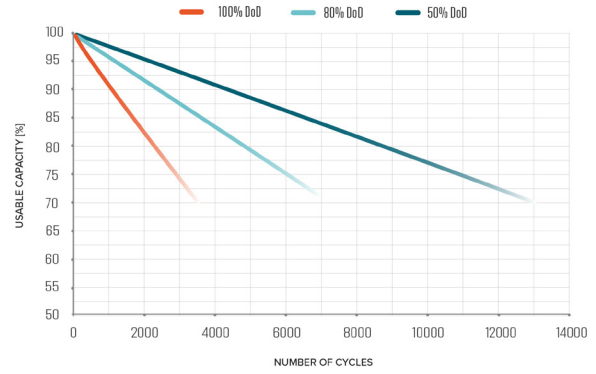

TYPICAL USABLE CAPACITY VS CYCLE LIFE FOR DIFFERENT DEPTHS OF DISCHARGE (0.5C, 25 °C)

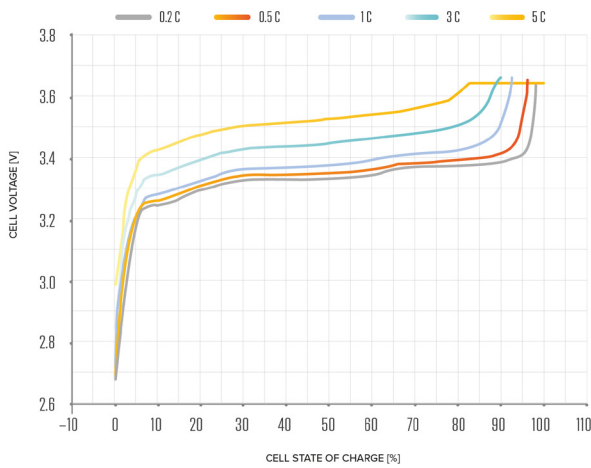

CELL VOLTAGE VS STATE OF CHARGE AT DIFFERENT CHARGE RATES (25 °C)

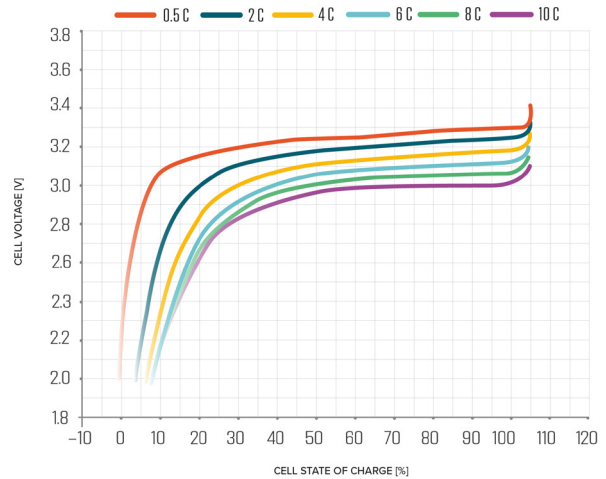

CELL VOLTAGE VS STATE OF CHARGE AT DIFFERENT DISCHARGE RATES (25 °C)

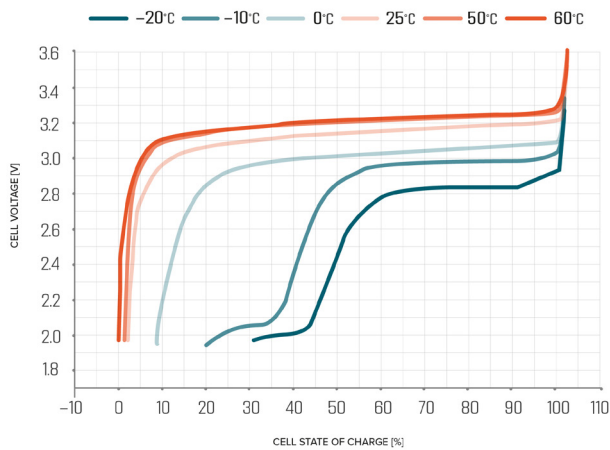

CELL VOLTAGE VS STATE OF CHARGE AT DIFFERENT TEMPERATURES

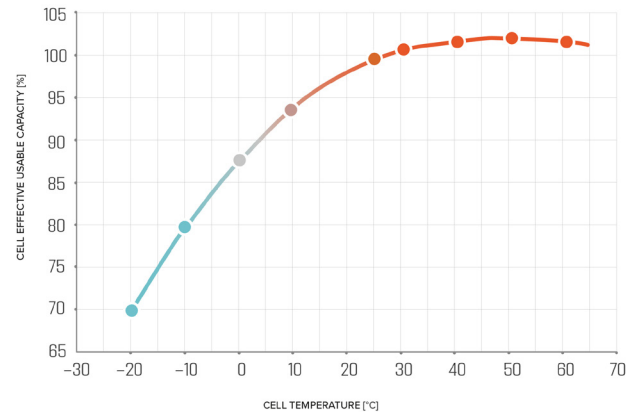

TYPICAL EFFECTIVE USABLE CAPACITY VS CELL TEMPERATURE